



**NUCLEAR
SHIELDS**



ALL CONFIGURATIONS
CATALOG
2025

WWW.NUCLEAR-SHIELDS.COM

TABLE OF CONTENTS

01 EQUIPMENT

Tungsten Syringe Shields	5
Lead Glass Syringe Shields	6
PET Syringe Shields	7
DUAL Syringe Shields	8
Beta Acryl Syringe Shields	9
Tungsten Vial Shields - Sliding	10
Tungsten Vial Shields - Magnetic	11
Lead Glass Vial Shields	12
Budget Vial Shields	13
Tungsten Containers	14
Lead Vial Pig	15
Syringe Carriers	16
Syringe Holder	17
Dose Drawing Station	18
PET Dose Drawing Station	19
Replacement Lead Glass	20

TABLE OF CONTENTS

02 MOBILE BARRIERS

Mobile PET Barriers	21
Mobile X-Ray Barriers	22

03 WORKING AREA

QC L-Block Workstation	23
Spect Workstation	24
Mobile PET Workstation	25
Cyclotron L-Block Station	26
Synthesis Workstation	27
Tabletop Workstations	28
Tabletop Shields	29
Shielded BSC	31
Lead Bricks	33
Dose Calibrator Shielding Rings	34

04 STORAGE

Shielded Safes	35
Safe Setups	36
Shielded Cabinets	37
Pass Trough Boxes	41
Mobile Lead Containers	43
Lead Containers	44

TABLE OF CONTENTS

05 DISPOSAL

Shielded Pedal Waste Bins	45
Mobile Waste Bins	46
Shielded Sharps Bins	49
Shielded Waste Bins	50

06 CONSTRUCTION

Lead Blankets	51
Lead Glass	55
Lead-Lined Gypsum Panels	58
Adhesive Lead Sheet & Parts	59
Lead Chevrons	61

TUNGSTEN SYRINGE SHIELDS

Our tungsten syringe shields designed to ensure optimized attenuation and reduce hand and finger doses. Designed for 1-10 ml syringes. Most syringe shield volumes are available in multiple internal dimensions for different syringe manufacturers. The inside is finished white so that the ml indicator on the syringe is clearly readable. The outside of each syringe shield comes in 5 colors, each color representing the ml syringe version. The body of the tungsten syringe shields is finished with anodized aluminum for easy cleaning and decontamination.



TUNGSTEN THICKNESS	LEAD GLASS THICKNESS	LEAD GLASS DENSITY	ACRYL THICKNESS
2mm	10mm	5,2 g/cm ³	n/a

TUNGSTEN THICKNESS	LEAD GLASS THICKNESS	LEAD GLASS DENSITY	ACRYL THICKNESS
2mm	10mm	5,2 g/cm ³	n/a

CLIP-LOCK PRODUCT CODE	CLIP-LOCK VOLUME	CLIP-LOCK INSIDE DIMENSIONS	CLIP-LOCK WEIGHT	CLIP-LOCK COLORS
SS2CL1-1	1 ml	Ø8.8x72mm	0,13KG	Green
SS2CL1-2	1 ml	Ø8.8x76mm	0,15KG	Green
SS2CL1-3	1 ml	Ø11.5x76mm	0,16KG	Green
SS2CL2-4	2 ml	Ø11.5x53mm	0,12KG	Grey/Silver
SS2CL2-5	2 ml	Ø11.5x60mm	0,13KG	Grey/Silver
SS2CL3-6	3 ml	Ø11.5x65mm	0,14KG	Yellow/Gold
SS2CL3-7	3 ml	Ø11.5x69mm	0,16KG	Yellow/Gold
SS2CL5-8	5 ml	Ø15.4x61mm	0,18KG	Blue
SS2CL5-9	5 ml	Ø15.4x65mm	0,19KG	Blue
SS2CL5-10	5 ml	Ø15.4x68mm	0,20KG	Blue
SS2CL10-11	10 ml	Ø18.2x75mm	0,22KG	Red
SS2CL10-12	10 ml	Ø18.2x85mm	0,25KG	Red

BIG-SCREW PRODUCT CODE	BIG-SCREW VOLUME	BIG-SCREW INSIDE DIMENSIONS	BIG-SCREW WEIGHT	BIG-SCREW COLORS
SS2BS1-1	1 ml	Ø8.8x72mm	0,13KG	Green
SS2BS1-2	1 ml	Ø8.8x76mm	0,15KG	Green
SS2BS1-3	1 ml	Ø11.5x76mm	0,15KG	Green
SS2BS2-4	2 ml	Ø11.5x53mm	0,12KG	Grey/Silver
SS2BS2-5	2 ml	Ø11.5x60mm	0,13KG	Grey/Silver
SS2BS3-6	3 ml	Ø11.5x65mm	0,14KG	Yellow/Gold
SS2BS3-7	3 ml	Ø11.5x69mm	0,16KG	Yellow/Gold
SS2BS5-8	5 ml	Ø15.4x61mm	0,16KG	Blue
SS2BS5-9	5 ml	Ø15.4x65mm	0,18KG	Blue
SS2BS5-10	5 ml	Ø15.4x68mm	0,19KG	Blue
SS2BS10-11	10 ml	Ø18.2x75mm	0,22KG	Red
SS2BS10-12	10 ml	Ø18.2x85mm	0,25KG	Red
SS2BS20-13	20 ml	Ø22.4x96mm	0,30KG	Orange
SS2BS30-14	30 ml	Ø26x109mm	0,61KG	
SS2BS50-15	50 ml	Ø31.4x120mm	0,63KG	

LEAD GLASS

SYRINGE SHIELDS

Our syringe shields with lead glass viewing window for optimal 360° visibility of the syringe. Designed for 1-10 ml syringes. Most syringe shield volumes are available in multiple internal dimensions for different syringe manufacturers. The clip-lock mechanism will make sure that the syringe is held in place. The anodized aluminum end cap is lined with 2 mm tungsten shielding on the inside to also provide shielding at the clip-lock mechanism, where the lead glass is not able to reach. This makes sure that you are optimally protected. The lead glass is fitted with a rubber lead glass protection ring. Available in 5 colors, each color representing the ml. syringe version. The body of the tungsten shielded body is finished with anodized aluminum for easy cleaning and decontamination.



TUNGSTEN THICKNESS	LEAD GLASS THICKNESS	LEAD GLASS DENSITY	ACRYL THICKNESS
2mm	7mm	5,2 g/cm ³	n/a

LEAD GLASS PRODUCT CODE	LEAD GLASS VOLUME	LEAD GLASS INSIDE DIMENSIONS	LEAD GLASS WEIGHT	LEAD GLASS COLORS
SS2LGCL1-1	1 ml	Ø8.8x72mm	0,15KG	Green
SS2LGCL1-2	1 ml	Ø8.8x76mm	0,16KG	Green
SS2LGCL1-3	1 ml	Ø11.5x76mm	0,19KG	Green
SS2LGCL2-4	2 ml	Ø11.5x53mm	0,14KG	Grey/Silver
SS2LGCL2-5	2 ml	Ø11.5x60mm	0,15KG	Grey/Silver
SS2LGCL3-6	3 ml	Ø11.5x65 mm	0,16KG	Yellow/Gold
SS2LGCL3-7	3 ml	Ø11.5x69 mm	0,17KG	Yellow/Gold
SS2LGCL5-8	5 ml	Ø15.4x61 mm	0,19KG	Blue
SS2LGCL5-9	5 ml	Ø15.4x65 mm	0,20KG	Blue
SS2LGCL5-10	5 ml	Ø15.4x68 mm	0,21KG	Blue
SS2LGCL10-11	10 ml	Ø18.2x75 mm	0,25KG	Red
SS2LGCL10-12	10 ml	Ø18.2x85 mm	0,28KG	Red

PET SYRINGE SHIELDS



Our tungsten syringe shields for PET with 8mm tungsten and our convenient Big-Screw locking mechanism. Designed for 1-10 ml syringes. Most syringe shield volumes are available in multiple internal dimensions for different syringe manufacturers. Available in Big-Screw mechanism. The inside is finished white so that the ml indicator on the syringe is clearly readable. The outside of each syringe shield comes in 5 colors, each color representing the ml syringe version. The body of the tungsten syringe shields is finished with anodized aluminum for easy cleaning and decontamination.



TUNGSTEN THICKNESS	LEAD GLASS THICKNESS	LEAD GLASS DENSITY	ACRYL THICKNESS
8mm	13mm	5,2 g/cm ³	n/a

PET PRODUCT CODE	PET VOLUME	PET INSIDE DIMENSIONS	PET WEIGHT	PET COLORS
SS2BS1-1P	1 ml	Ø8.8x72mm	0,61KG	Green
SS2BS1-2P	1 ml	Ø8.8x76mm	0,65KG	Green
SS2BS1-3P	1 ml	Ø11.5x76mm	0,75KG	Green
SS2BS2-4P	2 ml	Ø11.5x53mm	0,53KG	Grey/Silver
SS2BS2-5P	2 ml	Ø11.5x60mm	0,60KG	Grey/Silver
SS2BS3-6P	3 ml	Ø11.5x65mm	0,64KG	Yellow/Gold
SS2BS3-7P	3 ml	Ø11.5x69mm	0,68KG	Yellow/Gold
SS2BS5-8P	5 ml	Ø15.4x61mm	0,73KG	Blue
SS2BS5-9P	5 ml	Ø15.4x65mm	0,77KG	Blue
SS2BS5-10P	5 ml	Ø15.4x68mm	0,80KG	Blue
SS2BS10-11P	10 ml	Ø18.2x75mm	1,00KG	Red
SS2BS10-12P	10 ml	Ø18.2x85mm	1,13KG	Red

DUAL SYRINGE SHIELDS

Our Dual Syringe Shields combine 4 mm tungsten and 5 mm perspex, offering dual protection as it protects against both gamma and beta radiation. This material combination makes the shield ideal for nuclear medicine applications where shielding multiple types of radiation is essential. The shield features a narrow viewing window with a thickness of 8,8mm and a density of 5,2 g/cm³, ensuring safe and precise handling without compromising visibility. Additionally, the syringe can be securely fixed in place using the Big-Screw, providing added stability and ease of use. Designed for optimal protection and efficiency.



TUNGSTEN THICKNESS	LEAD GLASS THICKNESS	LEAD GLASS DENSITY	LEAD GLASS THICKNESS
4mm	8,8mm	5,2g/cm ³	10mm

DUAL SYRINGE SHIELD PRODUCT CODE	DUAL SYRINGE SHIELD VOLUME	DUAL SYRINGE SHIELD INSIDE DIMENSIONS	DUAL SYRINGE SHIELD WEIGHT	DUAL SYRINGE SHIELD COLORS
SS23BS5-8	5 ml	Ø15.4x61mm	0,48KG	Blue
SS23BS5-9	5 ml	Ø15.4x65mm	0,51KG	Blue
SS23BS5-10	5 ml	Ø15.4x68mm	0,54KG	Blue
SS23BS10-11	10 ml	Ø18.2x75mm	0,61KG	Red
SS23BS10-12	10 ml	Ø18.2x85mm	0,73KG	Red
SS23BS20-13	20 ml	Ø 22.4x89mm	0,86KG	Orange
SS23BS20-14	20 ml	Ø 22.4x96mm	0,93KG	Orange

BETA ACRYL SYRINGE SHIELDS

Our syringe shields with acrylic viewing window for optimal 360° visibility of the syringe and its contents. Made of 10 mm lightweight acrylic plastic. Designed for 1-10 ml syringes. Most syringe shield volumes are available in multiple internal dimensions for different syringe manufacturers. The big screw mechanism will make sure that the syringe is held in place. Available in 1ml, 2ml, 3ml, 5ml and 10ml sizes.



TUNGSTEN THICKNESS	LEAD GLASS THICKNESS	LEAD GLASS DENSITY	ACRYL THICKNESS
n/a	n/a	n/a	10mm

BETA ACRYL PRODUCT CODE	BETA ACRYL VOLUME	BETA ACRYL INSIDE DIMENSIONS	BETA ACRYL WEIGHT	BETA ACRYL COLORS
SS3BS1-1	1 ml	Ø8.8x72mm	0,058KG	n/a
SS3BS1-2	1 ml	Ø8.8x76mm	0,061KG	n/a
SS3BS1-3	1 ml	Ø11.5x76mm	0,069KG	n/a
SS3BS2-4	2 ml	Ø11.5x53mm	0,050KG	n/a
SS3BS2-5	2 ml	Ø11.5x60mm	0,056KG	n/a
SS3BS3-6	3 ml	Ø11.5x65mm	0,060KG	n/a
SS3BS3-7	3 ml	Ø11.5x69mm	0,063KG	n/a
SS3BS5-8	5 ml	Ø15.4x61mm	0,066KG	n/a
SS3BS5-9	5 ml	Ø15.4x65mm	0,069KG	n/a
SS3BS5-10	5 ml	Ø15.4x68mm	0,072KG	n/a
SS3BS10-11	10 ml	Ø18.2x75mm	0,087KG	n/a
SS3BS10-12	10 ml	Ø18.2x85mm	0,097KG	n/a

TUNGSTEN SLIDING CAP VIAL SHIELDS

Enhance your safety with our Tungsten Vial Shields, featuring a sliding septum cap designed for optimal protection. When the eluate vial is not in use, this cap ensures that the contents remain secure and shielded. Ideal for laboratories, medical facilities, and research institutions, our Tungsten Vial Shields are not only functional but also designed with user experience in mind. They provide a practical and reliable solution for handling sensitive materials with confidence and precision. Available in 4 mm or 6 mm tungsten (W) shielding.



VS214SG (4 MM TUNGSTEN)

TUNGSTEN THICKNESS	LEAD GLASS THICKNESS	LEAD GLASS DENSITY
4mm	10mm	5,2g/cm ³

VS216SG (6 MM TUNGSTEN)

TUNGSTEN THICKNESS	LEAD GLASS THICKNESS	LEAD GLASS DENSITY
6mm	10mm	5,2g/cm ³

PRODUCT CODE	VOLUME	INSIDE DIMENSIONS	WEIGHT	COLORS
VS214SG-G	15R	Ø27x61mm	1,22KG	Green
VS214SG-S	15R	Ø27x61mm	1,22KG	Silver
VS214SG-Y	15R	Ø27x61mm	1,22KG	Yellow/Gold
VS214SG-B	15R	Ø27x61mm	1,22KG	Blue
VS214SG-R	15R	Ø27x61mm	1,22KG	Red
VS216SG-G	15R	Ø27x61mm	1,72KG	Green
VS216SG-S	15R	Ø27x61mm	1,72KG	Silver
VS216SG-Y	15R	Ø27x61mm	1,72KG	Yellow/Gold
VS216SG-B	15R	Ø27x61mm	1,72KG	Blue
VS216SG-R	15R	Ø27x61mm	1,72KG	Red

TUNGSTEN MAGNETIC LID

VIAL SHIELDS

Boost your safety with our Tungsten Vial Shields, equipped with a magnetic lid to securely store radioisotope vials. This lid ensures that the contents stay protected and shielded when the eluate vial is not in use. Perfect for use in laboratories, medical facilities, and research institutions, our Tungsten Vial Shields are designed with both functionality and user experience in mind. They offer a reliable and practical solution for handling sensitive materials with precision and confidence. Available in 4 mm or 6 mm tungsten (W) shielding.

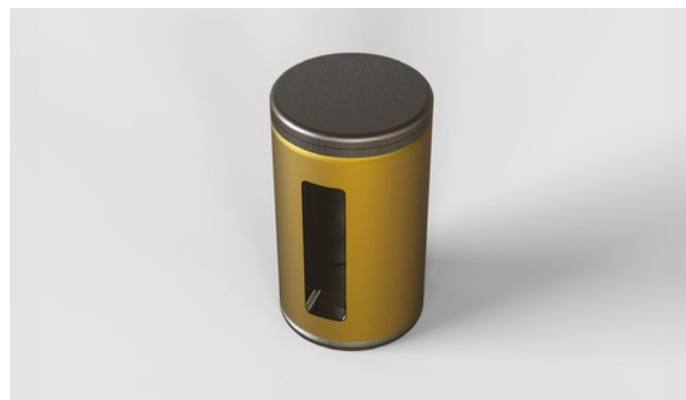

VS14MSG (4 MM TUNGSTEN)

TUNGSTEN THICKNESS	LEAD GLASS THICKNESS	LEAD GLASS DENSITY
4mm	10mm	5,2g/cm ³

VS16MG (6 MM TUNGSTEN)

TUNGSTEN THICKNESS	LEAD GLASS THICKNESS	LEAD GLASS DENSITY
6mm	10mm	5,2g/cm ³

PRODUCT CODE	VOLUME	INSIDE DIMENSIONS	WEIGHT	COLORS
VS214MG-G	15R	Ø27x61mm	1,23KG	Green
VS214MG-S	15R	Ø27x61mm	1,23KG	Silver
VS214MG-Y	15R	Ø27x61mm	1,23KG	Yellow/Gold
VS214MG-B	15R	Ø27x61mm	1,23KG	Blue
VS214MG-R	15R	Ø27x61mm	1,23KG	Red
VS216MG-G	15R	Ø27x61mm	1,72KG	Green
VS216MG-S	15R	Ø27x61mm	1,72KG	Silver
VS216MG-Y	15R	Ø27x61mm	1,72KG	Yellow/Gold
VS216MG-B	15R	Ø27x61mm	1,72KG	Blue
VS216MG-R	15R	Ø27x61mm	1,72KG	Red

LEAD GLASS

VIAL SHIELDS

Tungsten Vial Shields with a lead glass viewing window completely covering the outside for maximum visibility. This Vial Shield has 4 mm tungsten shielding, with a 12.5 mm lead glass viewing window. The cap of the Vial Shield is engineered for both security and convenience, utilizing strong magnets for a firm hold while still allowing for effortless removal. Simply twist the cap to access the elution hole, enabling safe and easy handling of sensitive materials. Ideal for high-precision environments, our Tungsten Vial Shields combine durability, visibility, and ease of use to meet the demanding needs of your industry.



TUNGSTEN THICKNESS	LEAD GLASS THICKNESS	LEAD GLASS DENSITY
4mm	12,5mm	5,2g/cm3

PRODUCT CODE	VOLUME	INSIDE DIMENSIONS	WEIGHT	COLORS
VSLG2112-G	30R	Ø33x58mm	1,10KG	Green
VSLG2112-S	30R	Ø33x58mm	1,10KG	Silver
VSLG2112-Y	30R	Ø33x58mm	1,10KG	Yellow/Gold
VSLG2112-B	30R	Ø33x58mm	1,10KG	Blue
VSLG2112-R	30R	Ø33x58mm	1,10KG	Red

BUDGET

VIAL

SHIELDS

Our Budget Vial Shields, offer a cost-effective solution for your laboratory's safety needs. Our Budget Vial Shield combines practicality and protection without compromising on quality, making it an ideal choice for environments requiring efficient radiation shielding on a budget. Designed with simplicity in mind, this shield does not include a viewing window, which helps us maintain its affordability while still providing effective protection. Our Budget Vial Shield has 3 mm Tungsten (W) shielding. Optimize your laboratory's safety with our reliable and cost-effective solution.



TUNGSTEN THICKNESS	LEAD GLASS THICKNESS	LEAD GLASS DENSITY
3mm	n/a	n/a

PRODUCT CODE	VOLUME	INSIDE DIMENSIONS	WEIGHT	COLORS
VS213	15R	Ø27x61 mm	0.47KG	n/a



TUNGSTEN CONTAINERS

VIAL SHIELDS

Enhance your safety with our Tungsten Vial Shields. Ideal for laboratories, medical facilities, and research institutions, our tungsten vial shields are not only functional but also designed with user experience in mind. They provide a practical and reliable solution for handling sensitive materials with confidence and precision. Available in the below designs.

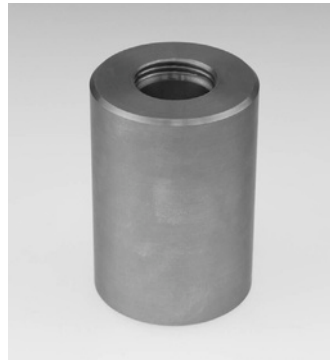

VS242 & VS246

PRODUCT CODE	TUNGSTEN THICKNESS	LEAD GLASS THICKNESS	LEAD GLASS DENSITY
VS242	20mm	n/a	n/a
VS246	6mm	n/a	n/a

VS252 & VS253

PRODUCT CODE	TUNGSTEN THICKNESS	LEAD GLASS THICKNESS	LEAD GLASS DENSITY
VS252	20mm	n/a	n/a
VS253	30mm	n/a	n/a

PRODUCT CODE	VOLUME	INSIDE DIMENSIONS	WEIGHT	COLORS
VS242	20R, 25R and 30R	Ø35x80mm	8KG	n/a
VS246	20R, 25R and 30R	Ø35x80mm	1,8KG	n/a
VS252	20R	Ø33x58mm	7,2KG	n/a
VS253	20R	Ø33x58mm	13,7KG	n/a

LEAD CONTAINER VIAL SHIELDS

Our Lead Vial Pig is crafted with 25 mm of Lead (Pb) shielding for superior radiation protection. This robust vial pig is the perfect solution for the secure handling and storage of highly radioactive materials, providing safety and reliability. Designed with functionality and user safety in mind, our vial pig features a streamlined design that facilitates easy handling and storage. The heavy-duty lead construction not only ensures effective shielding but also enhances the durability of the container, making it a long-lasting addition to any facility.

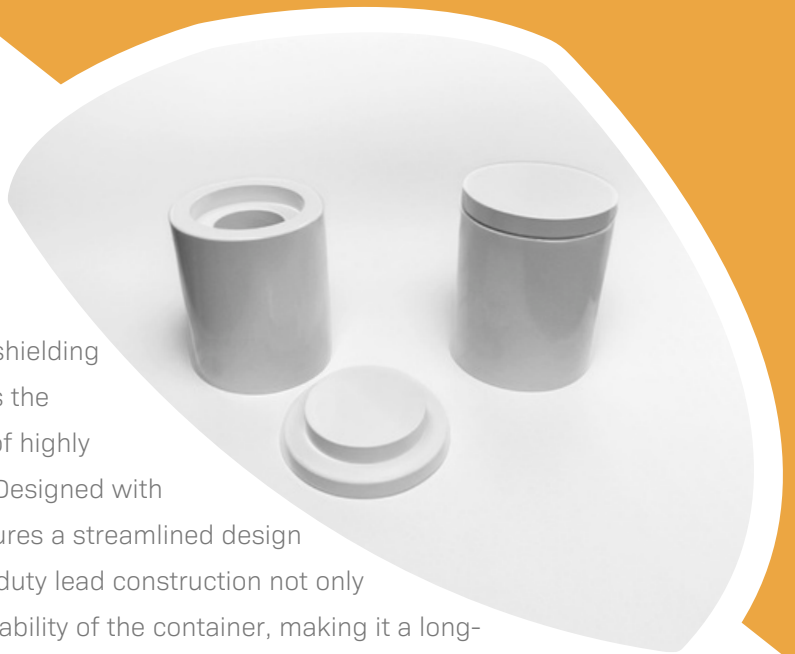

LEAD THICKNESS		LEAD GLASS THICKNESS		LEAD GLASS DENSITY	
25mm		n/a		n/a	

PRODUCT CODE	VOLUME	INSIDE DIMENSIONS	WEIGHT	COLORS
LVP112	20R, 25R	Ø44x70mm	7,3kg	Epoxy painted lead, white

**SSC113, SSC116
& SSC1110**

SYRINGE CARRIERS

Our Syringe Carriers are designed to provide secure and efficient protection when handling syringes containing radioactive materials. These carriers come in various shielding levels to ensure optimal safety across different applications in medical and laboratory environments. The SSC113 is equipped with 3mm lead shielding, For enhanced protection, the SSC116 features 6mm lead shielding, making it ideal for handling syringes with a bit higher radiation levels. For maximum protection, the SSC1110 provides 10mm lead shielding in the bottom, top, front and back, with 18mm lead shielding on the sides, ensuring robust safety when dealing with higher level radioactive materials.

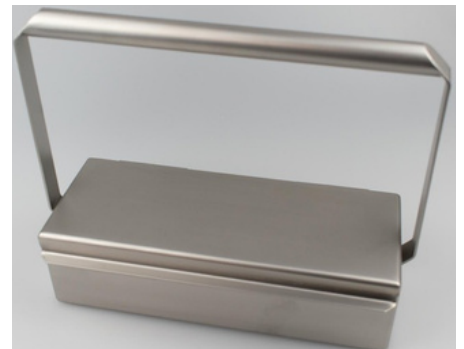
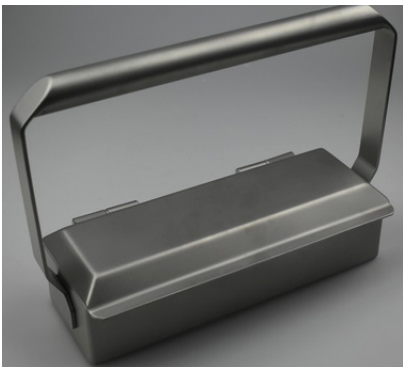
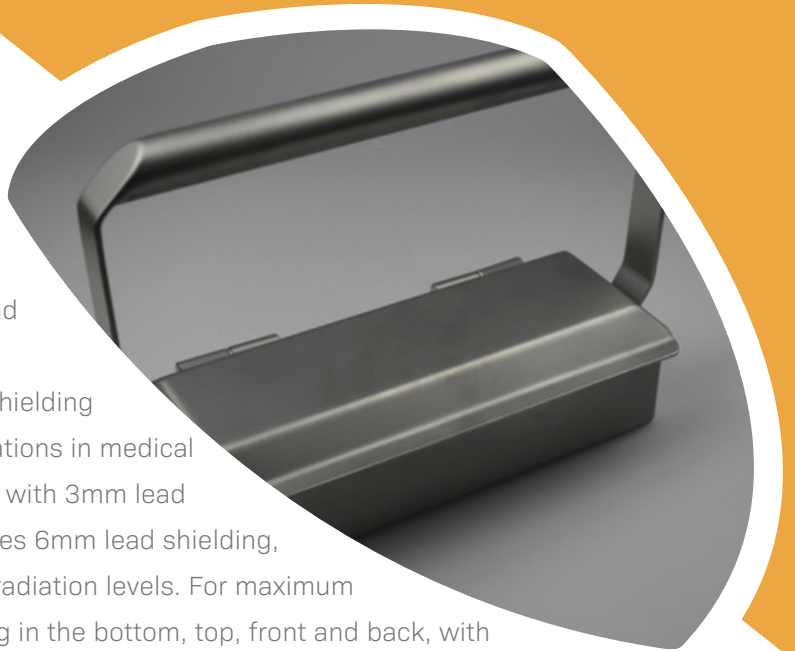

PRODUCT CODE	LEAD THICKNESS	INSIDE DIMENSIONS	WEIGHT	FINISHING MATERIAL
SSC113	3mm	225x60x45mm	4,8KG	Stainless steel, inside and outside
SSC116	6mm	225x60x45mm	7,3KG	
SSC1110	10mm in bottom, top, front & back 18mm in the sides	225x60x45mm	11,7KG	

SH112R SYRINGE HOLDER

The Shielded Syringe Holder SH112R is a practical and safe solution for securely holding syringes containing radioactive materials. Designed with integrated lead shielding, it ensures optimal radiation protection while working with syringes. The holder also includes an integrated recapper, allowing for the safe recapping of syringes after use, minimizing the risk of accidental needle sticks. Ideal for use in medical, laboratory, and radiopharmaceutical settings, the SH112R combines safety, radiation protection, and workflow efficiency in one compact solution.



PRODUCT CODE	LEAD THICKNESS	INSIDE DIMENSIONS	WEIGHT	
SH112R	12,5mm	ø60x137mm	5,1KG	

VSDDS

DOSE DRAWING STATION

The Dose Drawing Station is designed to hold magnetic-, sliding- and lead glass vial shields in place while you safely extract a substance from the vial. The arm can be adjusted to fit the required angle. It also creates an ergonomic working position. The dose drawing station ensures that there is good visibility of the vial and its contents. you also get three place holders for our Syringe Shields, so you have all the required products together to deliver a dose to the patient.

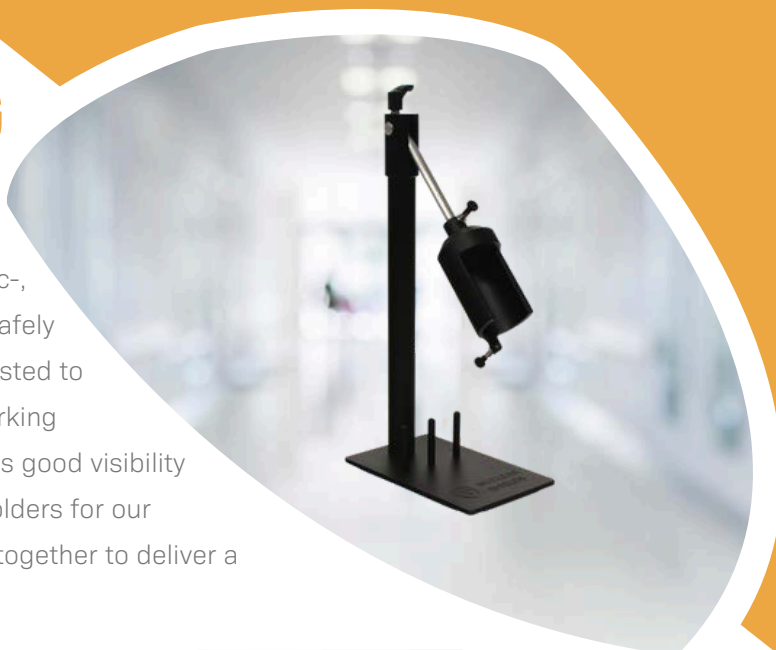

PRODUCT CODE	ANGLE	OUTSIDE DIMENSIONS	WEIGHT	APPLICATION
VSDDS	45° - 90°	125x200x405mm	1,2KG	Magnetic-, Sliding and Lead Glass Vial Shields

PET PET DOSE DRAWING STATION

The PET dose drawing station is a compact setup designed for safe and efficient preparation of PET doses. It consists of two main components: a tungsten pot (**VS273**) for shielding and a stainless steel rack (**VS273DDSR**) that securely holds the pot in position. Together, these two items form a practical station that ensures radiation protection during dose preparation, while keeping the working area organized and easy to clean.



PRODUCT CODE	ANGLE OR SHIELDING	OUTSIDE DIMENSIONS	INSIDE DIMENSIONS	WEIGHT
VS273	30mm Tungsten	Ø106x157m	Ø33x63m	15,4KG
VS273DDSR	Angle can be manually adjusted	230x250x295mm ^m	^m N/A	

REPLACEMENT LEAD GLASS

Ensure continued protection and clear visibility with our Replacement Lead Glass for our vial and syringe shields. Keep your shields functioning at their best with high-quality replacement lead glass.



The replacement glasses are suitable for the following syringe shield & vial shield ranges:

- Big-Screw Syringe Shields (SS2BSXXX)
- Clip-Lock Syringe Shields (SS2CLXXX)
- PET Syringe Shields (SS2BSXXX-P)
- Magnetic Tungsten Vial Shields (VS214MG-X & VS216MG-X)
- Sliding Tungsten Vial Shields (VS214SG-X & VS216SG-X)

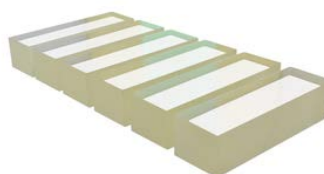

BIG SCREW & CLIP LOCK	PET	VIAL SHIELD		
LG-SS1-1	LG-SS1-1P	LG-VS		
LG-SS1-2	LG-SS1-2P			
LG-SS1-3	LG-SS1-3P			
LG-SS2-4	LG-SS2-4P			
LG-SS2-5	LG-SS2-5P			
LG-SS3-6	LG-SS3-6P			
LG-SS3-7	LG-SS3-7P			
LG-SS5-8	LG-SS5-8P			
LG-SS5-9	LG-SS5-9P			
LG-SS5-10	LG-SS5-10P			
LG-SS10-11	LG-SS10-11P			
LG-SS10-12	LG-SS10-12P			

MB111, MB112 & MB113 MOBILE PET BARRIERS

Our Mobile PET Barriers provide flexible, high-level radiation protection for use in PET imaging environments, with varying levels of shielding to suit different needs. The MB111 is equipped with 10mm lead shielding. The MB112 offers 20mm lead shielding. For environments requiring the highest level of radiation safety, the MB113 features 30mm lead shielding, offering maximum protection while still maintaining ease of movement. These barriers ensure optimal safety for personnel, and their mobile design enhances convenience and workflow flexibility.



PRODUCT CODE	LEAD THICKNESS	OUTSIDE DIMENSIONS	WEIGHT	SHIELDING AREA
MB111	10mm	603x984x1658mm	146KG	418x1454mm
MB112	20mm	603x984x1677mm	220KG	418x1474mm
MB113	30mm	623x984x1704mm	298KG	418x1500mm

PRODUCT CODE	LEAD GLASS THICKNESS	LEAD GLASS VIEWING WINDOW SIZE	LEAD GLASS DENSITY
MB111	27,5mm	294x220mm	4,77g/cm3
MB112	55mm	294x220mm	4,77g/cm3
MB113	82,5mm	294x220mm	4,77g/cm3

MXB112 & MXB110 MOBILE X-RAY BARRIERS

Our Mobile X-ray Barriers provide superior protection in X-ray environments. The MXB112 features 2mm lead shielding with lead glass, offering lightweight mobility for general use. For higher protection needs, the MXB110 comes with 10mm lead shielding and lead glass, ensuring maximum safety in high-radiation areas. Both models are designed for easy movement and clear visibility, ensuring optimal protection and flexibility in clinical settings.

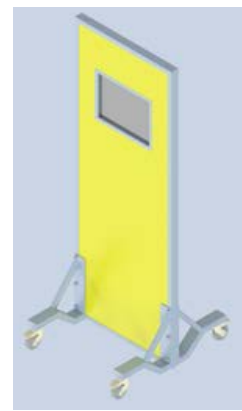
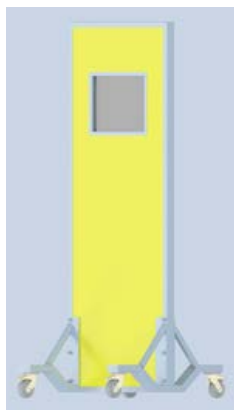
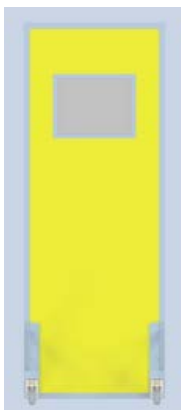

PRODUCT CODE	LEAD THICKNESS	OUTSIDE DIMENSIONS	WEIGHT
MXB112	2mm	743x904x2004mm	150KG
MXB110	10mm	743x904x2004mm	232KG

PRODUCT CODE	LEAD GLASS THICKNESS	LEAD GLASS VIEWING WINDOW SIZE	LEAD GLASS DENSITY
MXB112	10mm	400x300mm	4,46g/cm ³
MXB110	28,50mm	400x300mm	4,77g/cm ³

SW125 & SW125/W QC L-BLOCK WORKSTATION

The QC L-BLOCK Workstation provides maximum safety and clear visibility when working with radioactive materials, thanks to its lead and lead glass shielding. It comes standard with a dose calibrator compartment, and an optional waste bin compartment is available. Ideal for laboratories and medical applications.



LEAD THICKNESS		LEAD GLASS THICKNESS		LEAD GLASS DENSITY	
50 mm		110mm		5.2g/cm3	
OUTSIDE DIMENSIONS			LEAD GLASS VIEWING WINDOW SIZE		
1008x658x1450mm			280x180mm		
PRODUCT CODE	WORKING AREA	INSIDE DIMENSIONS WASTE BIN COMPARTMENT	INSIDE DIMENSIONS DOSE CALIBRATOR COMPARTMENT	WEIGHT	
SW125	880x530x255mm	N/A	ø177x472mm	1185KG	
SW125/W	880x530x255mm	246x253x396mm	ø177x472mm	1700KG	

SW 1205 SPECT WORKSTATION

The SPECT Workstation is designed with 5mm lead shielding, providing reliable radiation protection during SPECT procedures. It includes a lead glass viewing window, allowing clear and safe visibility of the work area. The workstation also comes standard with a dose calibrator compartment and a waste bin compartment, ensuring a well-organized and safe workspace. Its compact and ergonomic design makes it ideal for efficient use in laboratories and medical environments.



LEAD THICKNESS		LEAD GLASS THICKNESS		LEAD GLASS DENSITY	
5mm		15mm		4,77g/cm ³	
OUTSIDE DIMENSIONS			LEAD GLASS VIEWING WINDOW SIZE		
1008x658x1370mm			284x184mm		
PRODUCT CODE	WORKING AREA	INSIDE DIMENSIONS WASTE BIN COMPARTMENT	INSIDE DIMENSIONS DOSE CALIBRATOR COMPARTMENT	WEIGHT	
SW1205	953x603x255mm	250x250x400mm	ø177x463mm	320KG	

SW 115

MOBILE PET WORKSTATION

The Mobile PET Workstation is designed for the safe handling of PET isotopes, combining lead shielding with mobility for maximum protection and convenience. It comes standard with a waste bin compartment and dose calibrator compartment. The workstation includes 20mm Pb shielding in the work surface and 50mm Pb shielding in the movable screen, ensuring robust radiation protection. Ideal for laboratories and medical facilities, it allows for easy movement between rooms without compromising safety.

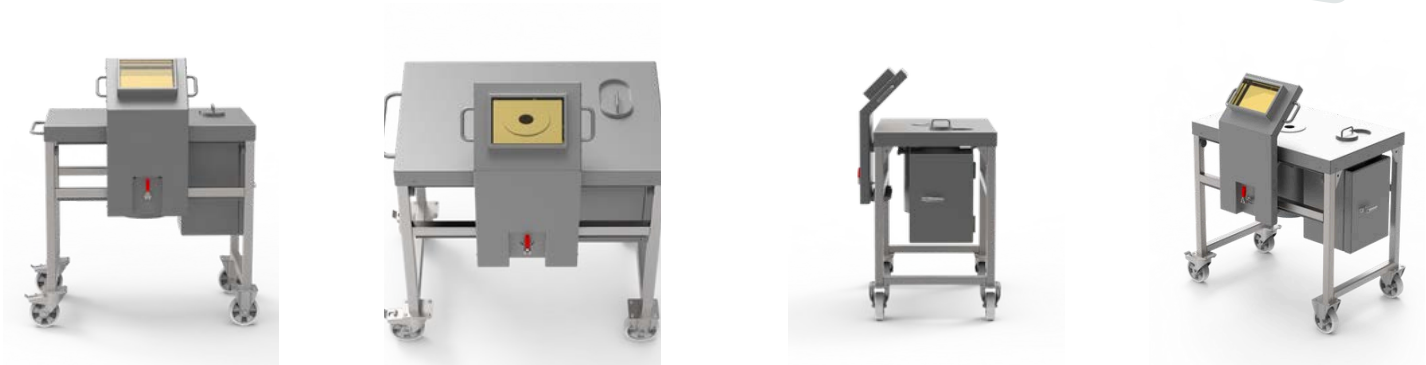

PRODUCT CODE	LEAD GLASS THICKNESS	LEAD GLASS DENSITY
SW115	110mm	5.2g/cm ³

OUTSIDE DIMENSIONS	LEAD GLASS VIEWING WINDOW SIZE
1220x802x1440mm	280x180mm

LEAD THICKNESS	WORKING AREA	INSIDE DIMENSIONS WASTE BIN COMPARTMENT	INSIDE DIMENSIONS DOSE CALIBRATOR COMPARTMENT	WEIGHT
50mm in movable screen 20mm in the work surface	1110x705mm	246x253x396mm	ø177x472mm	1455KG

SW135

CYCLOTRON L-BLOCK STATION

The Cyclotron L-Block Station is designed to provide maximum radiation shielding for high-energy cyclotron operations and maintenance tasks. With robust lead shielding integrated into the workstation, including 50mm Pb in the L-block and lead glass for clear visibility, it ensures optimal safety for personnel handling radioactive materials. It also features two shielded storage compartments underneath the working area for safe material storage. Ideal for use in radiopharmaceutical production, research settings, and cyclotron maintenance.



PRODUCT CODE	LEAD GLASS THICKNESS	LEAD GLASS DENSITY
SW135	110mm	5.2g/cm3

OUTSIDE DIMENSIONS	LEAD GLASS VIEWING WINDOW SIZE
991x709x1371mm	280x180mm

LEAD THICKNESS	WORKING AREA	INSIDE DIMENSIONS SHIELDING COMPARTMENTS	WEIGHT
50mm	880x531mm	308x398x507mm total 308x398x204mm with shelves	2578KG

SW155

SYNTHESIS WORKSTATION

This Synthesis Workstation is designed specifically for the safe handling and operation of synthesis modules. The synthesis module can be securely placed inside the work area, offering robust radiation protection. Easy access is provided through a front door, allowing operators to safely interact with the module while maintaining full shielding. Ideal for radiopharmaceutical production and laboratory settings.



PRODUCT CODE	LEAD GLASS THICKNESS	LEAD GLASS DENSITY
SW155	75mm	4,77g/cm ³

OUTSIDE DIMENSIONS	LEAD GLASS VIEWING WINDOW SIZE	WEIGHT
1600x600x1560mm	310x360mm	2200KG

LEAD THICKNESS	WORKING AREA	INSIDE DIMENSIONS SYNTHESIS COMPARTMENT	INSIDE DIMENSIONS BOTTOM COMPARTMENTS
50mm in sides and front 10mm in the backside 10mm in the workbench	1485x485x620mm	1485x485x620mm	710x585x560mm 710x585x255mm per shelf

SW145 & SW148

TABLETOP WORKSTATIONS

The Tabletop Shielded Workstation is designed for handling small-scale radioactive materials in a safe and efficient manner. This compact workstation is ideal for laboratories and medical environments, providing 5mm lead shielding as standard for optimal protection. For applications requiring enhanced beta shielding, the SW148 is also available in a variant with 8mm lead shielding and shielding for Beta. This versatility ensures that you can choose the right protection level for your specific needs.



LEAD GLASS VIEWING WINDOW SIZE	LEAD GLASS THICKNESS	LEAD GLASS DENSITY
200x240mm	15mm	4,77g/cm ³

PRODUCT CODE	SHIELDING THICKNESS	INSIDE DIMENSIONS WORKING AREA	WEIGHT	OUTSIDE DIMENSIONS
SW145	5mm Pb	565x362x293mm	73KG	609x430x475mm
SW148	8mm Pb & 5mm Al	565x362x293mm	133KG	636x460x493mm

**TTS111, TTS112, TTS113
& TTS1105B**

TABLETOP SHIELDS

The TTS Series offers a range of tabletop shields designed for safe handling of radioactive materials. Models TTS111, TTS112, and TTS113 feature robust lead shielding, while the TTS1105B is designed specifically with enhanced beta shielding. Each shield includes a large viewing window, providing clear, safe visibility while working with materials. These shields are ideal for laboratory and medical applications, delivering optimal protection without compromising usability.

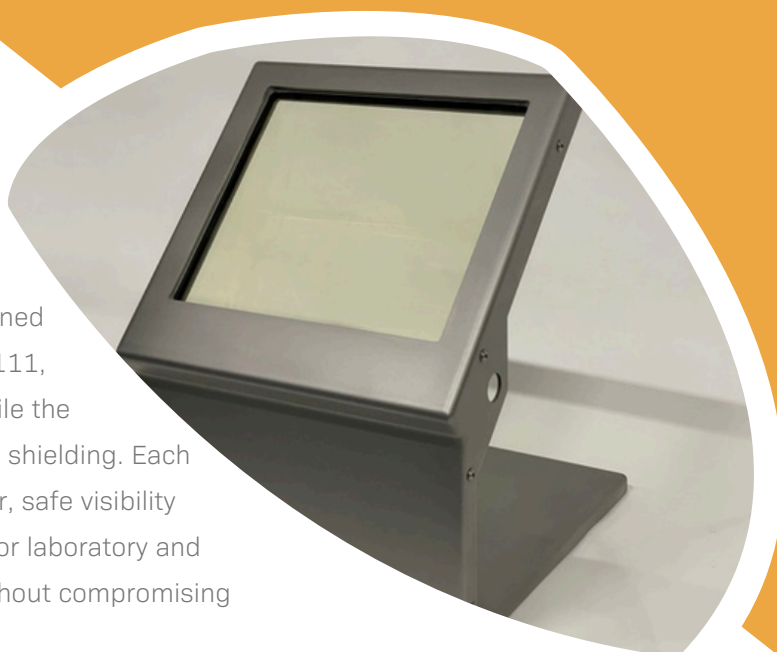

PRODUCT CODE	LEAD THICKNESS	OUTSIDE DIMENSIONS	WEIGHT	DISCRIPTION
TTS1105B	5mm Pb & 5mm Al	416x486x549mm	52KG	Beta L-Block Shield
TTS111	12,5mm	422x484x559mm	72KG	12,5mm L-Block Shield
TTS112	20mm	422x505x580mm	135KG	20mm L-Block Shield
TTS113	30mm	426x516x604mm	190KG	30mm L-Block Shield

PRODUCT CODE	LEAD GLASS THICKNESS	LEAD GLASS VIEWING WINDOW SIZE	LEAD GLASS DENSITY
TTS1105B	15mm	339x372mm	4,77g/cm3
TTS111	35mm	342x293mm	4,77g/cm3
TTS112	55mm	342x293mm	4,77g/cm3
TTS113	70mm	342x293mm	4,77g/cm3

**TTS115, TTS133
& TTS2112**

TABLETOP SHIELDS

The TTS115, TTS1221, and TTS133 tabletop shields are designed to provide reliable radiation protection in a compact form factor. These shields are perfect for use in laboratories, hospitals, and research environments where handling radioactive materials requires safety and visibility. Each model features lead shielding for optimal protection and a viewing window for clear, unobstructed visibility while working. The TTS2112 & TTS13 only has shielding at the front.



TTS2112



TTS115



TTS133

PRODUCT CODE	LEAD THICKNESS	OUTSIDE DIMENSIONS	WEIGHT	DISCRIPTION
TTS115	50mm	425x550x590mm	243KG	50mm L-Block Shield
TTS2112	12mm in front	320x250x520mm	30KG	12mm L-Block Shield
TTS133	3mm	350x450x350mm	20KG	3mm Corner Tabletop Shield

PRODUCT CODE	LEAD GLASS THICKNESS	LEAD GLASS VIEWING WINDOW SIZE	LEAD GLASS DENSITY
TTS115	112mm	220x190mm	5,2g/cm3
TTS2112	15mm	272x195mm	4,77g/cm3
TTS133	8mm	300x75mm	4,77g/cm3

BSC12-1-XX-XXXX SHIELDED BSC

Nuclear Shields' Shielded Biological Safety Cabinet offers advanced radiation protection combined with biological containment, making it the ideal solution for environments requiring both. This cabinet is customizable with various configurations to meet specific operational needs. Different lead shielding thicknesses are available to provide tailored radiation protection, and optional features include a generator compartment, waste bin compartment, and a dose calibrator compartment for added functionality. For enhanced usability, you can also choose to integrate a monitor in the back of the working area.



AVAILABLE SIZES OF BSC	INSIDE DIMENSIONS PER SIZE	OUTSIDE DIMENSIONS PER SIZE	BSC TYPE OPTION	OPTIONAL
Size 1	940x600x660mm	Depending on shielding thickness	Class 2 Type A2	24" Monitor in back wall
Size 2	1150x600x660mm			
Size 3	1350x600x660mm		Class 2 Type B2	
Size 4	1625x600x660mm			
Size 5 (only A2)	1800x600x660mm			

LEAD THICKNESS OPTIONS WORKING AREA	LEAD THICKNESS OPTIONS DOSE CALIBRATOR COMPARTMENT	LEAD THICKNESS OPTIONS WASTE BIN COMPARTMENT	LEAD THICKNESS OPTIONS GENERATOR COMPARTMENT	LEAD GLASS LEAD SHIELDING EQUIVALENT OPTIONS
5mm	10mm	10mm	25mm	5mm
10mm	20mm	20mm	50mm	10mm
20mm	50mm	30mm	75mm	20mm
30mm				30mm
50mm				50mm

BSC12-1-XX-XXXX

PRODUCT CODE CHART

When ordering or requesting a Shielded Biological Safety Cabinet, our product code chart is a helpful tool to ensure you select the correct configuration tailored to your specific needs. The chart allows you to choose from various options, including different lead shielding thicknesses and optional compartments such as a generator compartment, waste bin compartment, or dose calibrator compartment. If a particular compartment is not required, simply enter a 0 in the chart for that option.

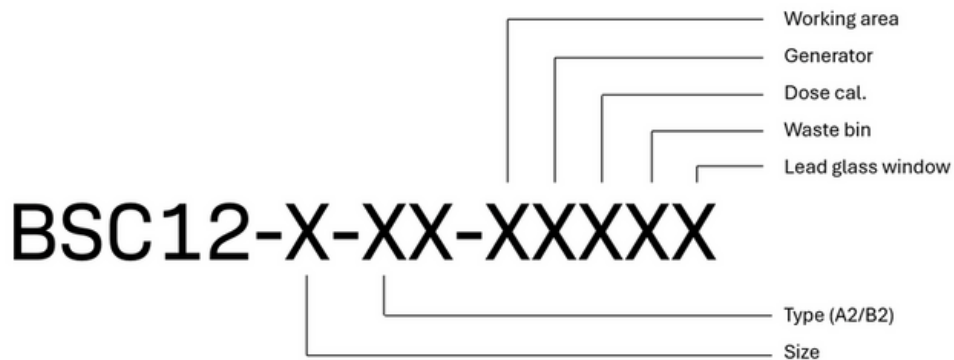

AVAILABLE SIZES OF BSC	BSC TYPE OPTION
Size 1 (1)	Class 2 Type A2 (A2)
Size 2 (2)	
Size 3 (3)	Class 2 Type B2 (B2)
Size 4 (4)	

LEAD THICKNESS OPTIONS WORKING AREA	LEAD THICKNESS OPTIONS DOSE CALIBRATOR COMPARTMENT	LEAD THICKNESS OPTIONS WASTE BIN COMPARTMENT	LEAD THICKNESS OPTIONS GENERATOR COMPARTMENT	LEAD GLASS SHIELDING EQUIVALENT OPTIONS
5mm (1)	10mm (1)	10mm (1)	25mm (1)	5mm (1)
10mm (2)	20mm (2)	20mm (2)	50mm (2)	10mm (2)
20mm (3)	50mm (3)	30mm (3)	75mm (3)	20mm (3)
30mm (4)				30mm (4)
50mm (5)				50mm (5)

SHIELDING LEAD BRICKS

Our Lead Bricks are designed for creating custom radiation shielding solutions in laboratories, medical facilities, and industrial environments. These bricks offer robust protection and can be easily stacked or arranged to fit specific needs. Ideal for building temporary or permanent shielding structures, they provide versatile and reliable protection against radiation exposure.

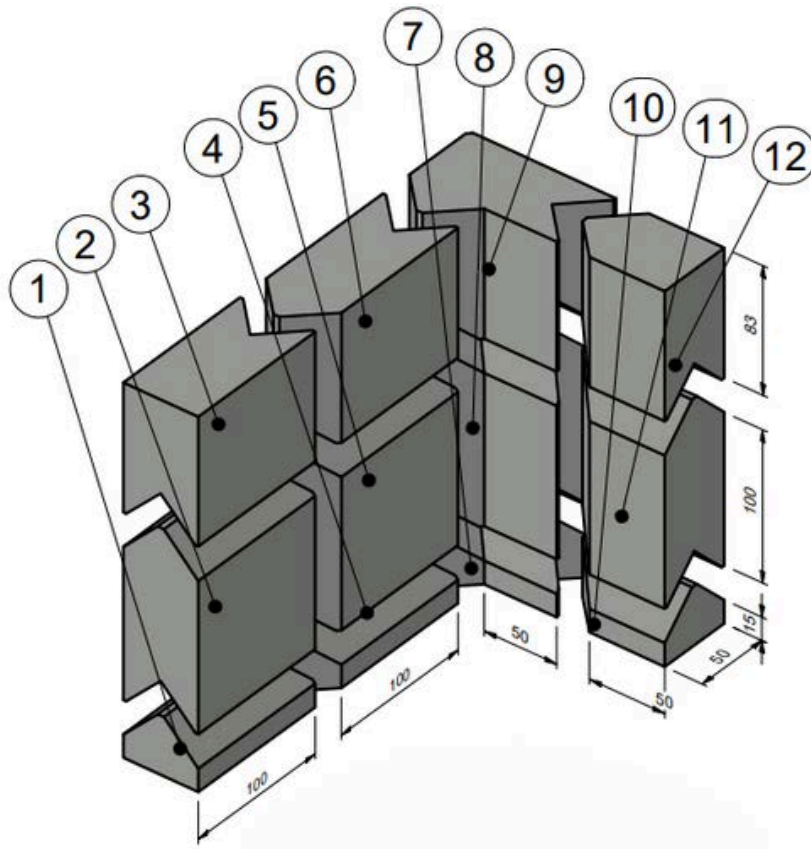

PRODUCT CODE	DISCRIPTION	ITEM NUMBER	WEIGHT	FINISHING MATERIAL
LB-50-BS	Base Start	1	1KG	Standard not painted Painting on request
LB-50-MS	Middle Start	2	3,5KG	
LB-50-TS	Top Start	3	2,5KG	
LB-50-B	Base Standard	4	1,6KG	
LB-50-M	Middle Standard	5	5,7KG	
LB-50-T	Top Standard	6	4,1KG	
LB-50-BC	Base Corner	7	1,6KG	
LB-50-MC	Middle Corner	8	5,7KG	
LB-50-TC	Top Corner	9	4,1KG	
LB-50-BE	Base End	10	1,3KG	
LB-50-ME	Middle End	11	5KG	
LB-50-TE	Top End	12	3,6KG	

LEAD DOSE CALIBRATOR SHIELDING RINGS

Our Dose Calibrator Shielding Rings provide essential radiation protection when working with dose calibrators in radiopharmaceutical settings. Available in 20mm or 50mm lead shielding, these rings offer flexible protection levels to suit varying safety requirements. Designed for easy integration with existing dose calibrators, they ensure optimal shielding during radioactive dose measurements, enhancing both safety and accuracy in your workflow.



PRODUCT CODE	LEAD THICKNESS	INSIDE DIMENSIONS	WEIGHT	FINISHING MATERIAL
LC-MED-50	50mm	ø130x336mm	120KG	Painted Lead
LC-MED-20	20mm	ø130x336mm	41KG	
LC-VVO-50	50mm	ø170x442mm	205KG	
LC-VVO-20	20mm	ø170x442mm	73KG	
LC-BIO-50	50mm	ø160x400mm	160KG	
LC-BIO-20	20mm	ø160x400mm	51KG	
LC-CAP-50	50mm	ø185x465mm	230KG	
LC-CAP-20	20mm	ø185x465mm	77 KG	

LEAD SHIELDED SAFES

Our Compact Lead Shielded Safes offer secure and efficient storage for radioactive materials in environments where space is limited. Designed with high-density lead shielding, these safes provide robust radiation protection while ensuring easy access to stored items. Ideal for laboratories, medical facilities, and research settings, the compact design maximizes safety without compromising on space or usability. These safes are perfect for securely storing vials, syringes, and other radioactive materials.



The safes can also be delivered with an optional bottom platform but needs to be ordered separately with article number SCXXXX-P

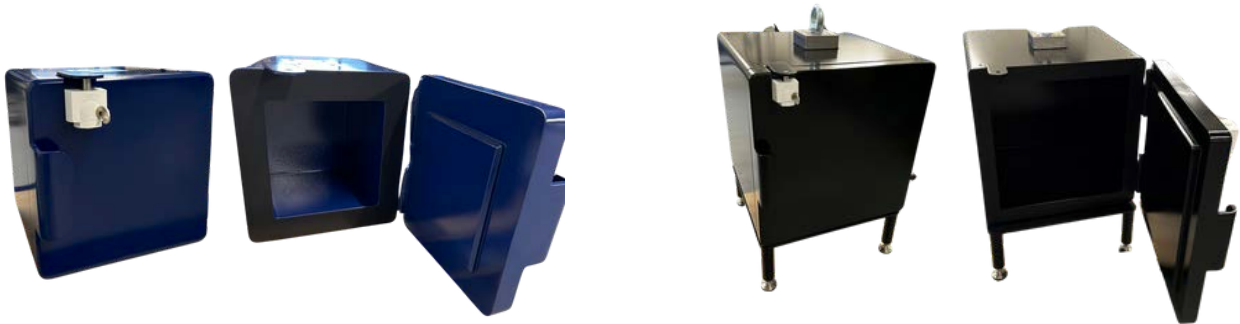

PRODUCT CODE	LEAD THICKNESS	INSIDE DIMENSIONS	WEIGHT	FINISHING MATERIAL
SC1317	17mm	334x334x200mm	200KG	Painted Steel and painted lead
SC1432	32mm	204x204x204mm	200KG	
SC1440	40mm	284x284x360mm	450KG	
SC1440-2	40mm	285x285x285mm	420KG	
SC14040	32mm	400x400x400mm	560KG	
SC1462	62mm	150x150x150mm	250KG	
SC1510	10mm	300x300x300mm	140 KG	

SHIELDED SAFE SETUPS

Our Compact Lead Shielded Safes can be conveniently stacked to create customized storage solutions. For example, they can be arranged in a 4x3 setup, maximizing space and offering flexible storage configurations for radioactive materials. This stackable design ensures that even in smaller environments, you can maintain a high level of radiation protection. Pricing is available upon request for these tailored safe setups, allowing you to optimize your storage solution based on your specific needs.



AVAILABLE COLORS			
RAL 1003	RAL 2002	RAL 9010	
RAL 6029	RAL 7035	RAL9005	RAL 5013

**DOOR WITH 4
RETRACTABLE SHELVES**

SHIELDED CABINETS



Nuclear Shields' Lead Shielded Cabinets offer effective radiation protection for environments where safety is essential, such as medical facilities, research labs, and nuclear applications. These cabinets come standard with a door and four pull-out shelves, providing easy access and organization. The cabinet is available in three different shielding thicknesses, ensuring tailored protection to meet specific safety requirements. Featuring high-density lead shielding for maximum protection, the robust stainless steel construction ensures durability. The front is finished with high-pressure laminate (HPL) in a variety of colors, and the cabinet is designed to meet diverse operational needs.

PRODUCT CODE	INSIDE DIMENSIONS OF SHELVES	OUTSIDE DIMENSIONS	WEIGHT	LEAD THICKNESS
SC1216	341x396x152mm	730x550x1005mm	270KG	6mm
SC1211	341x396x152mm	730x550x1005mm	420KG	12,5mm
SC1212	341x396x152mm	730x550x1005mm	710KG	25mm

CUSTOM OPTIONS

LOCKS
Standard one use-keyed
Combi-keyed
Option on request: Padlock

COLORS
RAL9016 (White)
RAL9001 (Creamy White)
RAL5010 (Gentian Blue)

RAL5011 (Steel Blue)
RAL7035 (Gray)
RAL1003 (Yellow)
RAL3000 (Red)

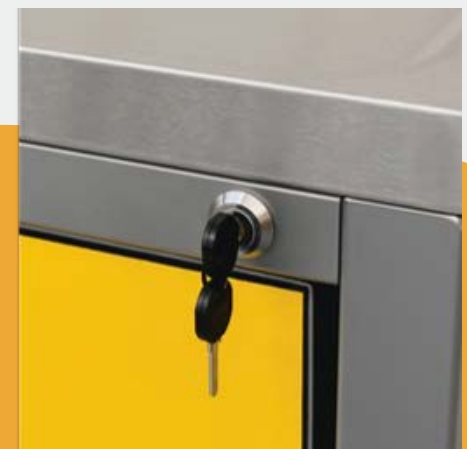

2 DRAWERS

SHIELDED CABINETS



Nuclear Shields' Lead Shielded Cabinets offer reliable radiation protection for environments such as medical facilities, research laboratories, and nuclear applications. This model comes standard with two drawers, providing convenient storage and easy access to radioactive materials. The cabinet is available in three different shielding thicknesses, ensuring tailored protection to meet specific safety requirements. Built with high-density lead shielding, the cabinet ensures maximum protection, while the durable stainless steel construction guarantees long-term use. The front is finished with high-pressure laminate (HPL) in a variety of colors to suit your preferences and operational needs.

PRODUCT CODE	INSIDE DIMENSIONS OF DRAWERS	OUTSIDE DIMENSIONS	WEIGHT	LEAD THICKNESS
SC1226	355x443x282mm	730x550x1005mm	300KG	6mm
SC1221	355x443x282mm	730x550x1005mm	450KG	12,5mm
SC1222	355x443x282mm	730x550x1005mm	720KG	25mm

CUSTOM OPTIONS

LOCKS
Standard one use-keyed
Combi-keyed
Option on request: Padlock

COLORS
RAL9016 (White)
RAL9001 (Creamy White)
RAL5010 (Gentian Blue)

RAL5011 (Steel Blue)
RAL7035 (Gray)
RAL1003 (Yellow)
RAL3000 (Red)



3 DRAWERS

SHIELDED CABINETS



Nuclear Shields' Lead Shielded Cabinets provide superior radiation protection for use in environments such as medical facilities, research laboratories, and nuclear applications. This model comes standard with three drawers, offering ample storage and easy access to radioactive materials. The cabinet is available in three different shielding thicknesses, allowing for customized protection based on your safety needs. Constructed with high-density lead shielding and durable stainless steel, the cabinet ensures long-term use. The front is finished with high-pressure laminate (HPL), available in a variety of colors to suit your operational and aesthetic preferences.

PRODUCT CODE	INSIDE DIMENSIONS OF DRAWERS	OUTSIDE DIMENSIONS	WEIGHT	LEAD THICKNESS
SC1236	355x443x156mm	730x550x1005mm	290KG	6mm
SC1231	355x443x156mm	730x550x1005mm	430KG	12,5mm
SC1232	355x 443x156mm	730x550x1005mm	730KG	25mm

CUSTOM OPTIONS

LOCKS	COLORS
Standard one use-keyed	RAL9016 (White)
Combi-keyed	RAL9001 (Creamy White)
Option on request: Padlock	RAL5010 (Gentian Blue)
	RAL5011 (Steel Blue)
	RAL7035 (Gray)
	RAL1003 (Yellow)
	RAL3000 (Red)



6 DRAWERS

SHIELDED CABINETS



Nuclear Shields' Lead Shielded Cabinets offer exceptional radiation protection for critical environments such as medical facilities, research labs, and nuclear applications. This model comes standard with six drawers, providing extensive storage space and easy access to radioactive materials. Available in three different shielding thicknesses, the cabinet can be customized to meet your specific safety requirements. Built with high-density lead shielding and robust stainless steel construction, it ensures durability and long-term use. The front is finished with high-pressure laminate (HPL) in a variety of colors, allowing you to tailor the cabinet to your operational and aesthetic needs.

PRODUCT CODE	INSIDE DIMENSIONS OF DRAWERS	OUTSIDE DIMENSIONS	WEIGHT	LEAD THICKNESS
SC1266	122x443x156mm	730x550x1005mm	280KG	6mm
SC1261	122x443x156mm	730x550x1005mm	440KG	12,5mm
SC1262	122x443x156mm	730x550x1005mm	740KG	25mm

CUSTOM OPTIONS

LOCKS	COLORS
Standard one use-keyed	RAL9016 (White)
Combi-keyed	RAL9001 (Creamy White)
Option on request: Padlock	RAL5010 (Gentian Blue)
	RAL5011 (Steel Blue)
	RAL7035 (Gray)
	RAL1003 (Yellow)
	RAL3000 (Red)



PTB1113

PASS TROUGH BOX

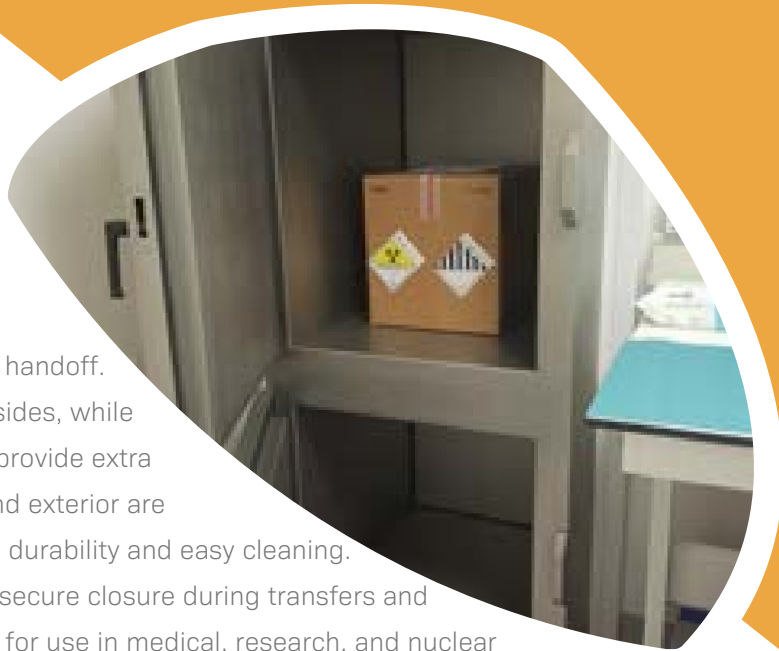

The Pass-Through Box PTB1113 is designed to safely transfer radioactive materials between controlled environments, featuring two compartments for secure handoff. The box is built with 10mm lead shielding around the sides, while the doors are reinforced with 30mm lead shielding to provide extra protection where it's needed most. Both the interior and exterior are constructed from high-quality stainless steel, ensuring durability and easy cleaning. Each door is equipped with a magnetic lock, ensuring secure closure during transfers and preventing unauthorized access. The PTB1113 is ideal for use in medical, research, and nuclear applications where radiation safety is essential.



LEAD THICKNESS	LEAD GLASS THICKNESS	LEAD GLASS DENSITY
30mm in the doors and 10mm around	n/a	n/a

OUTSIDE DIMENSIONS	LEAD GLASS VIEWING WINDOW SIZE
753x817x1671mm	n/a

PRODUCT CODE	INSIDE DIMENSIONS BOTTOM COMPARTMENT	INSIDE DIMENSIONS TOP COMPARTMENT	WEIGHT
PTB1113	596x671x612mm	596x671x750mm	1275KG

PTB112LG PASS TROUGH BOX

The Pass-Through Box PTB112LG is designed for the secure transfer of radioactive materials, featuring one compartment with advanced safety measures. This model is equipped with 5mm lead shielding and a lead glass viewing window, providing clear visibility while maintaining optimal radiation protection. Additionally, the PTB112LG is fitted with a HEPA filter, ensuring a clean air environment during material transfers. Built from high-quality stainless steel both inside and out, it offers durability and ease of maintenance. The PTB112LG is an ideal solution for environments requiring safe, controlled material handling, such as laboratories and nuclear facilities.



LEAD THICKNESS	LEAD GLASS THICKNESS
5mm	5mm Pb eq. at 140 Kev

OUTSIDE DIMENSIONS	LEAD GLASS VIEWING WINDOW SIZE
614x759x536mm	200x200mm

PRODUCT CODE	INSIDE DIMENSIONS	WEIGHT	OPTIONAL
PTB112LG	400x400x400mm	150KG	Bottom support frame

SWB135

MOBILE LEAD CONTAINER

The Mobile Lead Container SWB135 is designed for the safe and efficient transport of radioactive materials. Featuring 50mm lead shielding, it offers robust protection, making it ideal for securely moving materials from point A to point B. The container can be easily lifted out of the cart, providing additional flexibility for storage or handling. Its mobile design ensures easy maneuverability, ensuring maximum safety in laboratories, hospitals, and industrial settings.



PRODUCT CODE	LEAD THICKNESS	INSIDE DIMENSIONS	WEIGHT	FINISHING MATERIAL
SWB135	50mm	ø60x127mm	63KG	Stainless steel outside painted lead inside

LSC1160 & LS0070-35

LEAD CONTAINERS

Our Lead Containers provide secure and reliable radiation shielding for the storage and transport of radioactive materials. The LSC1160 features 60mm lead shielding, offering maximum protection for handling high-level radioactive substances, making it ideal for use in environments with stringent safety requirements. The LS0070-35 comes with 35mm lead shielding, providing excellent protection while being a more lightweight and versatile option for lower-level radiation materials. Both containers are built to ensure the highest level of safety in laboratories, hospitals, and industrial settings.



LS0070-35

LSC1160

PRODUCT CODE	LEAD THICKNESS	INSIDE DIMENSIONS	WEIGHT	FINISHING MATERIAL
LS0070-35	35mm	ø80x175mm	43KG	Stainless steel outside painted lead inside
LSC1160	60mm	ø70x120mm	91KG	

SWB153 & SWB156 SHIELED PEDAL WASTE BINS

The Pedal Shielded Waste Bins provide reliable radiation shielding for safe disposal of radioactive waste. Available with either 3mm or 6mm lead shielding, these bins ensure optimal protection in environments handling radioactive materials. They come in three different volume capacities—27L, 45L, and 80L—offering flexibility to suit various needs. The pedal-operated design allows for hands-free operation, enhancing both safety and convenience. The SWB153-80L comes standard with movable wheels underneath the waste bin.



80L



27L & 45L

PRODUCT CODE	LEAD THICKNESS	INSIDE DIMENSIONS	WEIGHT	FINISHING MATERIAL
SWB153-27L	3mm	280x280x375mm	30KG	Stainless steel outside painted lead inside
SWB156-27L	6mm	274x274x372mm	50KG	
SWB153-45L	3mm	280x280x525mm	37KG	
SWB156-45L	6mm	274x274x523mm	65KG	
SWB153-80L	3mm	443x375x572mm	92KG	
SWB153-P	Optional Mobile Platform for SWB153-27L, SWB153-45L, SWB156-27L & SWB156-45L			

**S0009, S0009-2
& SWB1935-27L**

MOBILE WASTE BINS

Our range of Mobile Waste Bins is designed to offer superior radiation shielding for safe and efficient waste disposal in environments handling radioactive materials. The S0009 model, equipped with 12mm lead shielding, delivers robust protection while maintaining easy mobility, making it ideal for general use in controlled environments. For higher radiation protection needs, the S0009-2 offers 25mm lead shielding, providing an extra layer of safety for handling more hazardous materials. For maximum protection, the SWB1935-27L is designed with 35mm lead shielding, making it the perfect choice for settings where the highest level of shielding is critical for safe waste handling. All of our mobile waste bins come with wheels for easy transport and feature hands-free operation, ensuring a combination of safety and convenience in demanding environments.



S0009 & S0009-2



SWB1935-27L

PRODUCT CODE	LEAD THICKNESS	INSIDE DIMENSIONS	WEIGHT	FINISHING MATERIAL
S0009	12mm	430x430x580mm	260KG	Stainless steel outside and inside
S0009-2	25mm	396x396x569mm	513KG	
SWB1935-27L	35mm	300x300x300mm	385KG	

LS0069 & SWB1106

MOBILE WASTE BINS

The LS0069 is a large mobile waste bin designed for the secure handling and disposal of radioactive waste. With its robust construction and mobility, this bin provides excellent radiation protection while allowing for easy transport of larger waste volumes in controlled environments. Ideal for use in labs, hospitals, and research facilities, the LS0069 ensures safe and efficient waste management. The SWB1106 Mobile Radioactive Waste Enclosure offers a practical solution for storing up to four 30L WIVA plastic containers. The top two compartments allow for the easy addition of radioactive waste. Once the containers are full, they can be moved to the bottom compartments for decay storage, optimizing space and ensuring a safe waste decay process. This design not only improves workflow but also provides enhanced safety in handling radioactive waste over extended periods.



SWB1106



LS0069

PRODUCT CODE	LEAD THICKNESS	INSIDE DIMENSIONS	WEIGHT	FINISHING MATERIAL
SWB1106	6mm	420x355x340mm Per compartment	220KG	Stainless steel outside and inside
LS0069	5mm	780x780x971mm	451KG	Stainless steel outside and 5mm PE liner on inside

SWB126-239L & SWB122-45L

MOBILE WASTE BINS

Our Mobile Waste Bins SWB126-239L and SWB122-45L are designed for flexible and secure radioactive waste management, featuring exchangeable handlebars for easy maneuverability. The SWB126-239L offers 6mm lead shielding and boasts a large internal capacity, making it ideal for handling substantial volumes of waste while ensuring reliable radiation protection. Its spacious design is perfect for environments that generate higher waste output, such as labs and medical facilities.

For enhanced shielding, the SWB122-45L is equipped with 20mm lead protection, providing superior safety for environments handling more hazardous radioactive materials. Despite its smaller volume capacity, this bin ensures robust protection while maintaining ease of movement through the exchangeable handlebars.



SWB126-239L



SWB122-45L

PRODUCT CODE	LEAD THICKNESS	INSIDE DIMENSIONS	WEIGHT	FINISHING MATERIAL
SWB126-239L	6mm	555x555x776mm	288KG	Stainless steel outside and inside
SWB122-45L	20mm	255x255x716mm	290KG	Stainless steel outside and inside

SWB113-8L & SWB116-8L

SHIELDED SHARPS BINS

Our Shielded Sharps Bins provide secure and reliable radiation protection for the disposal of radioactive sharps, ensuring a safe work environment in laboratories, hospitals, and research facilities. Available in 3mm, 6mm, and 25mm lead shielding, these bins offer varying levels of protection to suit different safety requirements. For added convenience, we also offer an optional plastic sharps bin insert that fits perfectly into our shielded sharps bins, allowing for easy replacement and enhanced hygiene during disposal.



PRODUCT CODE	LEAD THICKNESS	INSIDE DIMENSIONS	WEIGHT	FINISHING MATERIAL
SWB113-8L	3mm	191x191x253mm	21KG	Stainless steel outside Painted lead inside
SWB116-8L	6mm	185x185x250mm	28KG	
SWB125-8L	12,5mm	191x191x250mm	60KG	
SWB250-8L	25mm	191x191x250mm	115KG	
SWB11X-I	Optional Plastic Sharps Container Insert for SWB113-8L, SWB116-8L & SWB1125-8L			

SWB193 & SWB141 SHIELDED WASTE BINS

The SWB193 Shielded Waste Bin is designed for secure disposal of radioactive waste in compact environments. With a capacity of 18 liters and 3mm lead shielding, its compact size and design make it ideal for tabletop placement, ensuring easy access and safe, efficient waste disposal in laboratories and medical settings. The SWB141 Cyclotron Target Waste Castle is engineered for the safe storage and decay of cyclotron target foils. With 100mm of lead shielding, it offers maximum radiation protection during the decay process, ensuring the highest level of safety. Specifically designed for cyclotron facilities, this waste castle provides a secure environment to store high-energy radioactive foils, allowing them to decay safely and efficiently before further disposal.



SWB193

SWB141

PRODUCT CODE	LEAD THICKNESS	INSIDE DIMENSIONS	WEIGHT	FINISHING MATERIAL
SWB193	3mm	250x150x525mm	27KG	Stainless steel outside Painted lead inside
SWB141	100mm	ø60x137mm	230KG	Painted lead outside Stainless steel insert on the inside

LEAD BLANKETS

Our lead blankets are made using high-density lead wool, providing superior flexibility and radiation attenuation. The continuous layering of lead wool rope minimizes gaps, ensuring consistent shielding. Designed for durability, they are available in various sizes, shapes, and weights to suit your specific needs. These blankets are widely used across the nuclear industry for effective shielding around components.

They offer 35% minimum attenuation on Cobalt-60 at 6 mm Pb equivalency



FIRE CLASS	EXTERNAL COVERING	EYELETS
Fire class M2 in accordance with NFP 92-503	Waterproof PVC laminated reinforced with nylon fibre	Up to 120 kg per eyelets, internal diameter 25mm

ARTICLE CODE	LEAD EQUIVALENCE	EFFECTIVE AREA	TOTAL SIZE	WEIGHT
LB116H	6mm Pb eq.	800x400mm	950x550mm	24 kg
LB156	6mm Pb eq.	400x400mm	550x550mm	13 kg
LB1112H	12mm Pb eq.	400x400mm	550x550mm	23 kg

**LEAD BLANKETS
OPTIONS & ACCESSORIES**

MOBILE RACKS

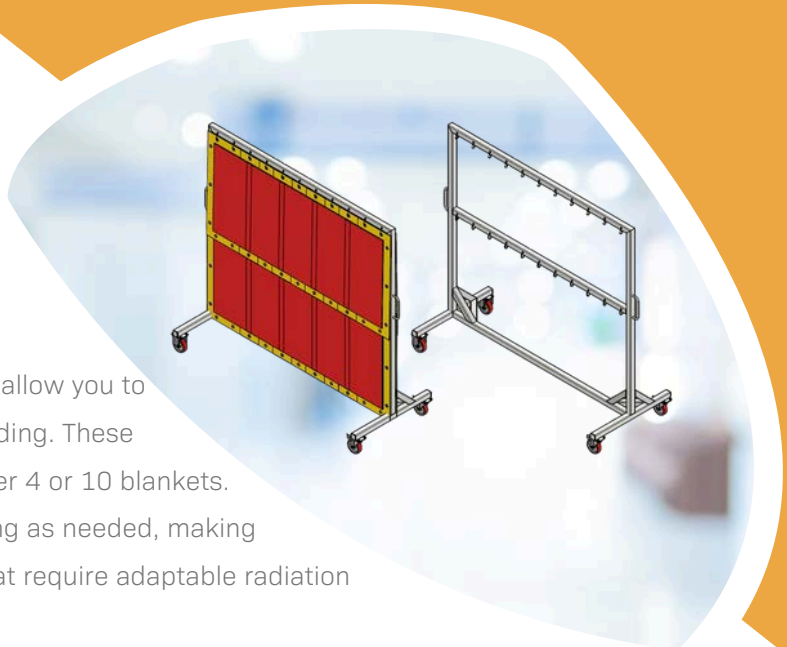

To add more flexibility, our mobile lead blanket racks allow you to hang LB116H blankets and use them as mobile shielding. These racks are available in two sizes, accommodating either 4 or 10 blankets. With their mobility, you can quickly reposition shielding as needed, making them a practical choice for dynamic environments that require adaptable radiation protection.

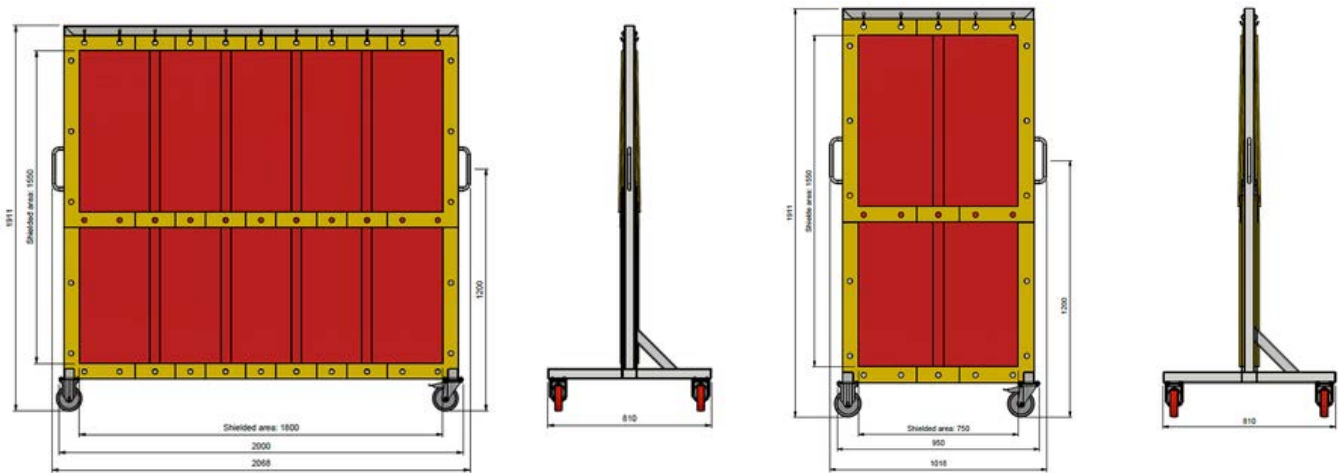

Lead blankets need to be ordered separate with the racks.

ARTICLE CODE	GENERAL REMARKS	EFFECTIVE AREA	TOTAL SIZE
E0024956	S-hooks on top for easier hanging	750x1550mm	1018x1911x810mm
E0024958	C-hooks on bottom to hang more flush without poking out	1800x1550mm	2068x1911x810mm
	Overlap between Lead blankets: 50mm		

LEAD BLANKETS
OPTIONS & ACCESSORIES

STORAGE CONTAINER

The storage container offers a secure and durable solution for storing your lead blankets. With capacities for up to **25pcs LB116H blankets, 50pcs LB156 blankets, or 43pcs LB112H blankets**, it provides ample space while keeping the blankets organized and protected.



ARTICLE CODE	OUTSIDE DIMENSIONS	MAX. LOAD
LBSC125	1200 x 800mm	1000 kg

LEAD BLANKETS
OPTIONS & ACCESSORIES

H-SHAPE LIFTING BEAM

For easy handling of the storage container, the H-Shape Lifting Beam is an excellent addition. This sturdy lifting beam makes transporting loaded containers safe and efficient, minimizing strain and protecting the blankets during movement. The maximum lifting weight is 1000 kg, which is the maximum weight of the storage containers. The lifting beam includes four chains with a length of 1000 mm.

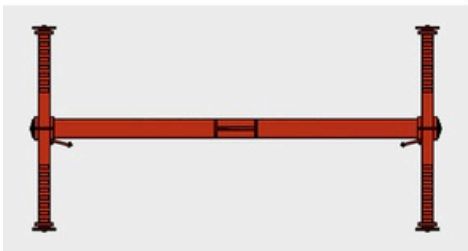
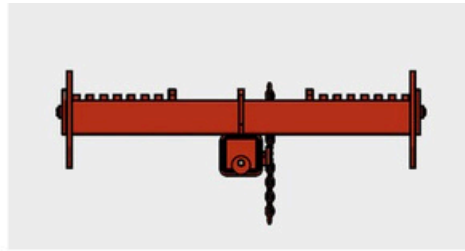
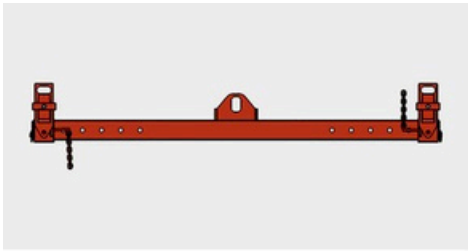

ARTICLE CODE	OUTSIDE DIMENSIONS	MAX. LOAD
LBSCLE1	2145 x 1073 mm	1000 kg

BUILDING MATERIALS

X-RAY

LEAD GLASS

X-ray lead glass provides reliable protection against X-ray radiation while maintaining clear visibility. The glass is enriched with lead oxide and barium, effectively absorbing radiation, making it suitable for medical, industrial, and scientific applications. We offer lead glass in various standard thicknesses, depending on the required level of protection. Common thicknesses range from 6 mm to 20 mm, with corresponding lead equivalencies for optimal radiation shielding. The glass can be easily integrated into walls, doors, and viewing windows.



PRODUCT CODE	LEAD EQUIVALENCE	DIMENSIONS	WEIGHT
LG2000x1000x20	4mm	2000x1000x20mm	
LG1500x900x20	4mm	1500x900x20mm	
LG1500x900x15	3mm	1500x900x15mm	
LG1200x800x10	2mm	1200x800x10mm	
LG1200x800x15	3mm	1200x800x15mm	
LG1200x800x20	4mm	1200x800x20mm	
LG900x600x10	2mm	900x600x10mm	
LG900x600x15	3mm	900x600x15mm	
LG900x600x20	4mm	900x600x20mm	

BUILDING MATERIALS

GAMMA LEAD GLASS

Gamma lead glass is specifically designed for protection against gamma radiation. With a high lead oxide content, it provides excellent radiation shielding while maintaining clear visibility. It is widely used in nuclear medicine, hot cells, laboratories, and industrial applications. Our gamma lead glass is available in various standard thicknesses, tailored to the required level of radiation protection. For enhanced safety, it can be combined with additional shielding materials.

Various sizes available in 4,77 g/cm³ or 5,2g/cm³ density



BUILDING MATERIALS

LEAD GLASS

Incl. LEAD FRAME

Our lead glass with lead frame provides high-level radiation shielding, available in 50 mm, 75mm or 100 mm Pb equivalency. This combination ensures optimal protection against X-ray and gamma radiation while maintaining clear visibility. Designed for hot cells and other shielded environments, the lead frame enhances structural integrity and simplifies installation in walls, doors, and viewing windows.

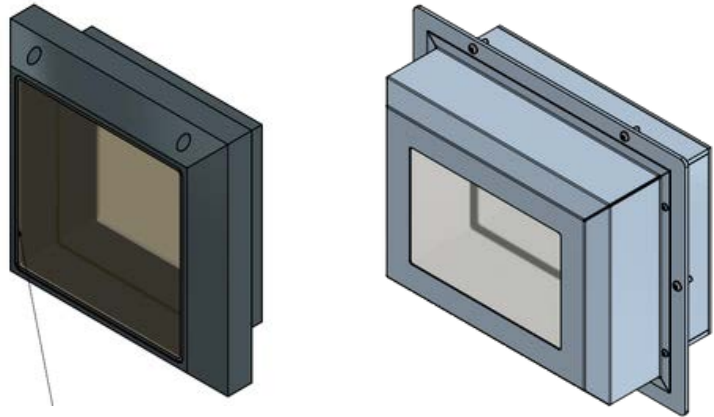
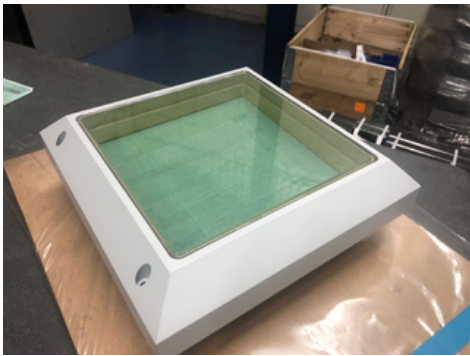
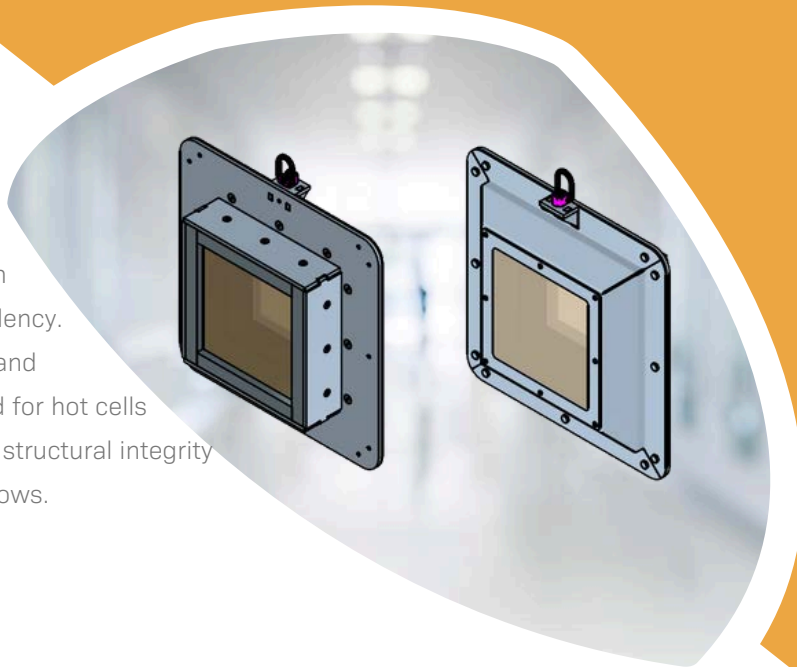

PRODUCT CODE	LEAD EQUIVALENCE	VIEWING WINDOW	WEIGHT	FINISHING MATERIAL
E0018321	30mm	229x229mm	46KG	Stainless steel enclosure around front side of glass
E0007469	50mm	250x250mm	65KG	Stainless steel enclosure around front side of glass
E0035679	75mm	200x200mm	175KG	Stainless steel enclosure around glass
E0035658	75mm	300x300mm	270KG	Stainless steel enclosure around glass
E0019748	100mm	300x200mm	260KG	Stainless steel enclosure around glass
E0019748	100mm	490x290mm	517KG	Stainless steel enclosure around glass

BUILDING MATERIALS **LEAD-LINED** **GYPSUM PANELS**

Our lead-lined gypsum panels provide effective radiation shielding for spaces such as X-ray rooms and laboratories. The panels consist of a 12.5 mm thick gypsum board, bonded with lead sheeting in thicknesses of 1 mm or 2 mm. Standard dimensions are 60 cm wide, with lengths of 260 cm or 300 cm.

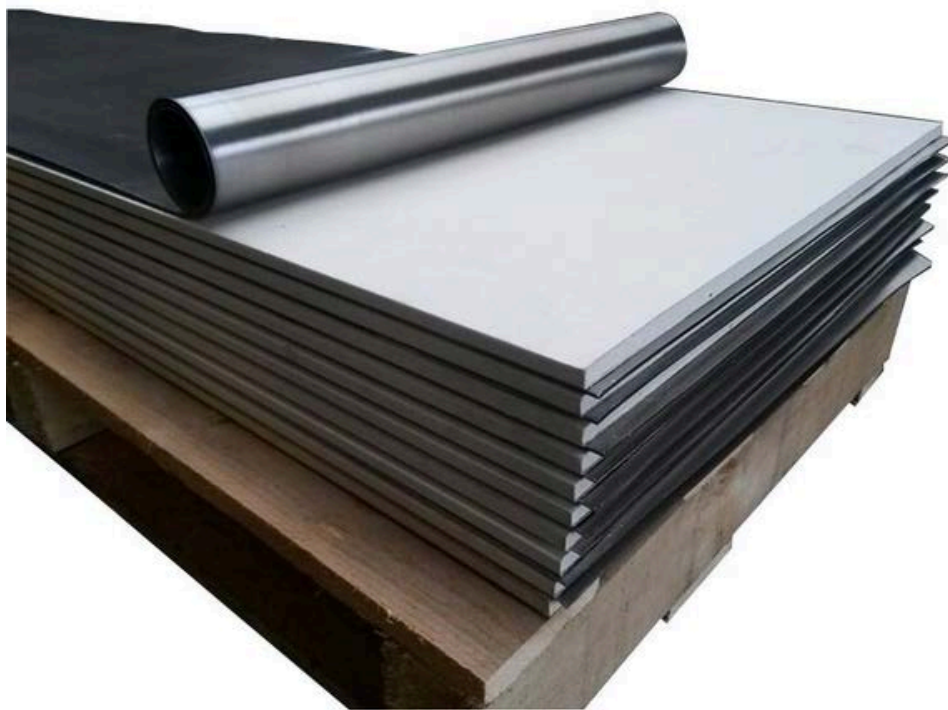
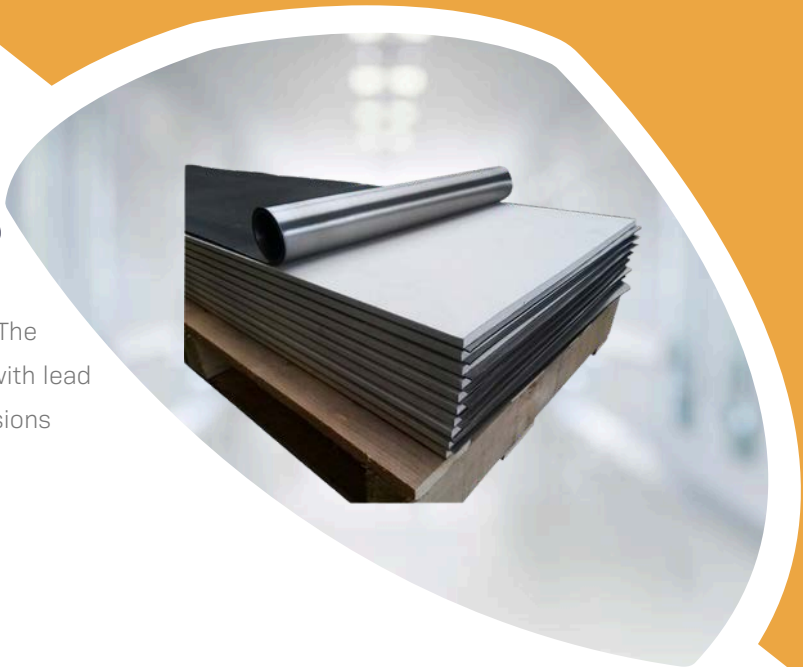

PRODUCT CODE	LEAD THICKNESS	DIMENSIONS	WEIGHT
RSW131M	1mm	600x2600mm	26KG
RSW132M	2mm	600x2600mm	49KG
RSW131L	1mm	600x3000mm	34KG
RSW132L	2mm	600x3000mm	57KG

BUILDING MATERIALS

ADHESIVE

LEAD STRIPS

Our adhesive lead strips provide easy-to-install radiation shielding for seams, joints, and small surfaces. They are available in 1 mm, 2 mm, and 3 mm thicknesses, ensuring effective protection against X-ray and gamma radiation. With a strong adhesive backing, these strips can be quickly applied to walls, doors, and frames



PRODUCT CODE	LEAD THICKNESS	DIMENSIONS	WEIGHT
RSW121	1mm	50x20.000mm	12KG
RSW122	2mm	50x10.000mm	12KG
RSW123	3mm	50x8000mm	14KG

BUILDING MATERIALS

ADHESIVE

LEAD SHEETS

Our adhesive lead sheet provides flexible and effective radiation shielding for medical, industrial, and construction applications.

Available in 0.5 mm, 1 mm, and 2 mm thicknesses, it features a strong adhesive backing for easy installation on various surfaces. Furthermore, they have a gray RAL 7016 coating.

In addition to standard sizes, we offer custom cutting to meet your specific requirements.



PRODUCT CODE	LEAD THICKNESS	DIMENSIONS	WEIGHT	FINISHING MATERIAL
RSW115L	0.5mm	1000x3000mm	17KG	RAL 7016 paint coating
RSW111L	1mm	1000x3000mm	34KG	RAL 7016 paint coating
RSW112L	2mm	1000x3000mm	68KG	RAL 7016 paint coating
RSW132L	2mm	600x3000mm	57KG	RAL 7016 paint coating

BUILDING MATERIALS

LEAD

CHEVRONS

Our lead chevron profiles provide effective radiation shielding for walls, doors, and enclosures. The interlocking design ensures a tight, gap-free fit, preventing radiation leakage. These profiles are ideal for medical, industrial, and research applications requiring high-level protection.

Specifications:

- Height: 100 mm
- Thicknesses: 8 mm, 10 mm, 12 mm, 15 mm, 20 mm, 25 mm
- Custom lengths available
- Cut options: 45° and 90° angles for precise installation



CONTACT

SALES & AFTERSALES

NUCLEAR SHIELDS B.V.

Akkervoortweg 29
5827AP Vortum-Mullem
The Netherlands

+31 (0)485 - 561140
info@nuclear-shields.com
www.nuclear-shields.com

CHAMBER OF COMMERCE

EINDHOVEN

REG. NR. : 67846769

VAT : NL857196881B01

ABOUT

NUCLEAR SHIELDS

Nuclear Shields is a manufacturer of radiation shielding based in the Netherlands with more than 50 years of experience. The production facility is designed to meet the requirements of long term serial production and one-off custom projects. Lines of communication are short due to our small team of sales and engineering personnel. The focus on good and fast communication with the client helps us improve our services every day and makes sure the customer is satisfied.

FACTORIES & OFFICES

VAN MULLEKOM GROUP

2

FACTORIES

3

OFFICES

3

CONTINENTS

80+

EMPLOYEES



Protecting today & Imaging the future

www.nuclear-shields.com